

# Kreuz- und Schiebetische Cross and slide tables

BAZIS

## Typ CP Type CP

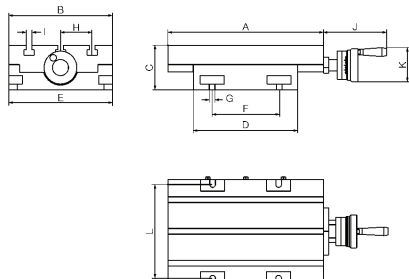
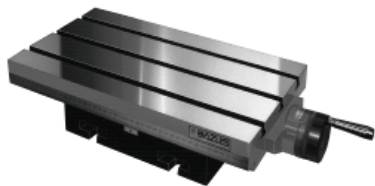

Stationäre Schiebetische mit einer Achse.

Stationary slide tables with 1 axis.

Typ CP / Type CP	A mm	B mm	C mm	D mm	E mm	F mm	L mm	G mm	H mm	I mm	J mm	K mm	T-Nuten / T-nuts
CP-0	230	164	66	164	164	-	-	-	50	10	56	56	3
CP-1	330	220	94	220	220	140	198	12	67	12	137	70	3
CP-2	430	240	100	260	240	150	216	16	72	12	135	70	3
CP-3	600	240	98	310	240	200	216	16	72	12	135	70	3
CP-4	800	240	110	415	240	300	216	16	72	12	140	100	3
CP-5	800	320	104	415	320	300	300	16	72	12	140	100	4

Typ CP / Type CP	X-Verfahrweg / X-Travel mm	Auflösung / Resolution mm	Gewinde Steigung / Thread lead	Max. Werkstückgewicht / Max. weight of workp. kg	Max. Arbeitsdruck / Max. pressure kg	Gewicht / Weight kg	Art.-Nr. / Order no.
CP-0	70	0,05	2	55	500	10	18-CP-0
CP-1	110	0,05	4	105	700	25	18-CP-1
CP-2	170	0,05	4	270	900	35	18-CP-2
CP-3	290	0,05	4	270	980	45	18-CP-3
CP-4	385	0,05	4	290	1200	62	18-CP-4
CP-5	385	0,05	4	290	1200	85	18-CP-5

## Typ MF Type MF

BAZIS

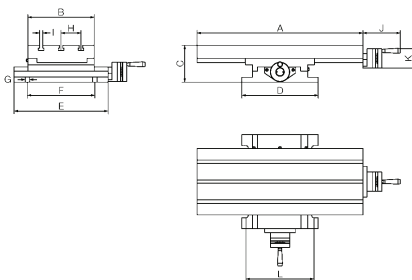

Stationäre Koordinatentische mit zwei Achsen.

Stationary cross tables with 2 axes.

Typ MF / Type MF	A mm	B mm	C mm	D mm	E mm	F mm	L mm	G mm	H mm	I mm	J mm	K mm	T-Nuten / T-nuts
MF-0	230	164	101	225	225	160	191	12	50	10	56	56	3
MF-1	330	220	125	256	280	210	210	16	67	12	137	70	3
MF-2	430	240	132	276	340	244	246	16	72	12	135	70	3
MF-3	600	240	133	276	340	244	246	16	72	12	135	70	3

Typ MF / Type MF	X-Verfahrweg / X-Travel mm	Y-Verfahrweg / Y-Travel mm	Auflösung / Resolution mm	Gewinde Steigung / Thread lead	Max. Werkst.gewicht / Max. weight of workp. kg	Max. Arbeitsdruck / Max. pressure kg	Gewicht / Weight kg	Art.-Nr. / Order no.
MF-0	120	110	0,05	2	55	500	16	18-MF-0
MF-1	190	130	0,05	4	105	700	33	18-MF-1
MF-2	240	160	0,05	4	270	900	46	18-MF-2
MF-3	350	160	0,05	4	270	980	56	18-MF-3

2  
25

Kreuz- und Schiebetische / Cross and slide tables



# Kreuztische Cross tables

## Typ MF DRILL Type MF DRILL

**BAZIS**



Stationäre Kreuztische mit zwei Achsen, mit zwei zusätzlichen Anschlägen für den X-Verfahrweg.

*Stationary cross table with 2 axes, additionally with 2 stops for X-travel.*

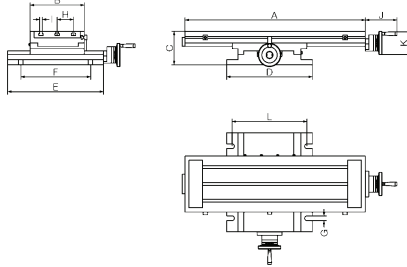

Typ MF DRILL / Type MF DRILL	A mm	B mm	C mm	D mm	E mm	F mm	L mm	G mm	H mm	I mm	J mm	K mm	T-Nuten / T-nuts
MF-2 Drill	430	240	133	276	340	244	246	16	72	12	140	100	3
MF-3 Drill	600	240	133	276	340	244	246	16	72	12	140	100	3
MF-4 Drill	800	240	144	380	425	310	332	20	72	12	140	100	3
MF-5 Drill	800	320	150	370	600	460	322	20	72	12	140	100	4
MF-6 Drill	800	320	229	480	800	610	430	20	72	12	-	100	4

Typ MF / Type MF	X-Verfahrweg / X-Travel mm	Y-Verfahrweg / Y-Travel mm	Auflösung / Resolution mm	Gewinde Steigung / Thread lead	Max. Werkstückgewicht / Max. weight of workp. kg	Max. Arbeits- druck / Max. pressure kg	Gewicht / Weight kg	Art.-Nr. / Order no.
MF-2 Drill	240	160	0,05	4	270	900	46	18-MF-2DRILL
MF-3 Drill	350	160	0,05	4	270	980	56	18-MF-3DRILL
MF-4 Drill	470	240	0,05	4	290	1200	86	18-MF-4DRILL
MF-5 Drill	470	300	0,05	4	290	1200	122	18-MF-5DRILL
MF-6 Drill	700	400	0,05	4	900	1350	290	18-MF-6DRILL

## Typ MG - drehbar Type MG - rotatable

**BAZIS**



Drehbare Koordinatentische mit zwei Achsen, für mechanische Anwendungen bei denen außer der Kontrolle des X-Y Verfahrweges noch eine Rotation des Tisches von  $\pm 90^\circ$  benötigt wird.

*Rotating cross table with 2 axes to enable performance of any mechanical application in which  $\pm 90^\circ$  rotation of the table is required apart from X-Y control.*

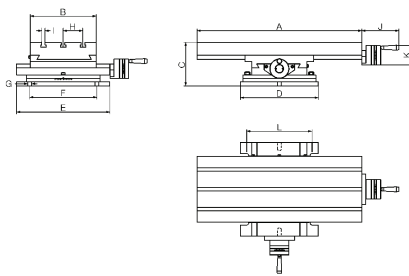

Typ MG / Type MG	A mm	B mm	C mm	D mm	E mm	F mm	L mm	G mm	H mm	I mm	J mm	K mm	T-Nuten / T-nuts
MG-0	230	164	120	213	250			12	50	10	56	56	3
MG-1	330	220	142	255	285	216	217	14	67	12	137	70	3
MG-2	430	240	150	284	340	245	238	16	72	12	135	70	3
MG-3	600	240	154	284	340	245	238	16	72	12	135	70	3
MG-4	800	240	180	368	425	305	338	20	72	12	140	100	3
MG-5	800	320	180	368	425	305	338	20	72	12	140	100	4

Typ MG / Type MG	X-Verfahrweg / X-Travel mm	Y-Verfahrweg / Y-Travel mm	Auflösung / Resolution mm	Gewinde Steigung / Thread lead	Max. Werkstückgewicht / Max. weight of workp. kg	Max. Arbeits- druck / Max. pressure kg	Gewicht / Weight kg	Art.-Nr. / Order no.
MG-0	120	110	0,05	2	55	500	22	18-MG-0
MG-1	190	130	0,05	4	105	700	38	18-MG-1
MG-2	240	160	0,05	4	270	900	55	18-MG-2
MG-3	350	160	0,05	4	270	980	65	18-MG-3
MG-4	470	240	0,05	4	290	1200	113	18-MG-4
MG-5	470	300	0,05	4	290	1200	126	18-MG-5



# Kreuztische MINI Cross tables MINI

BAZIS

## Typ MF MINI Type MF MINI

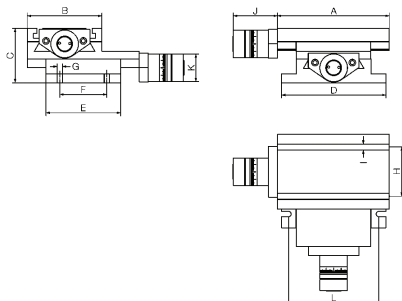
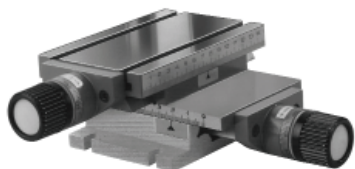

Stationäre Koordinatentische mit zwei Achsen, entwickelt für Anwendungen in der Feinmechanik sowie für Versuchs- und Messlabore.

Stationary cross tables with 2 axes, designed for fine mechanics or laboratory applications.

Typ mini / Type mini	A mm	B mm	C mm	D mm	E mm	F mm	L mm	H mm	I mm	J mm	K mm	T-Nuten
MF-100	150	100	73	140	100	63	121	66	8	60	37	2
MF-200	200	100	85	140	100	63	121	66	8	60	37	2

Typ MINI / Type MINI	X-Verfahrweg / X-Travel mm	Y-Verfahrweg / Y-Travel mm	Auflösung / Resolution mm	Gewinde Steigung / Thread lead	Max. Werkstückgewicht / Max. weight of workp. kg	Max. Arbeits- druck / Max. pressure kg	Gewicht / Weight kg	Art.-Nr. / Order no.
MF-100	50	50	0,025	P-1,75	40	250	6	18-MF-100
MF-200	100	100	0,025	P-1,75	40	250	6,5	18-MF-200

## Typ MG MINI - drehbar Type MG MINI - rotatable

BAZIS

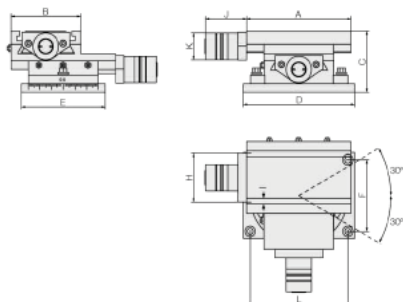
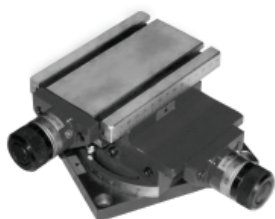

Drehbare Koordinatentische mit zwei Achsen, wie Ausführung MF MINI, jedoch mit zusätzlicher Rotationsmöglichkeit von  $\pm 30^\circ$ .

Rotating cross table with 2 axes, identical to MF MINI, but with the possibility of performing  $\pm 30^\circ$  rotation.

Typ MINI / Type MINI	A mm	B mm	C mm	D mm	E mm	F mm	L mm	H mm	I mm	J mm	K mm	T-Nuten
MG-100	150	100	85	160	120	100	140	66	8	60	37	2
MG-200	200	100	87	160	120	100	140	66	8	60	37	2

Typ MINI / Type MINI	X-Verfahrweg / X-Travel mm	Y-Verfahrweg / Y-Travel mm	Auflösung / Resolution mm	Gewinde Steigung / Thread lead	Max. Werkstückgewicht / Max. weight of workp. kg	Max. Arbeits- druck / Max. pressure kg	Gewicht / Weight kg	Art.-Nr. / Order no.
MG-100	50	50	0,025	P-1,75	45	255	7	18-MG-100
MG-200	100	100	0,025	P-1,75	45	255	75	18-MG-200

